



**MODULAR DESIGN**

**THE SOLERA AREA LIGHT FEATURES A MODULAR DESIGN.** The battery is built into the solar panel, and the light engine can be mounted in multiple configurations. No need for a power source, which eliminates the need for trenching & wiring. High performance solar controller maximizes solar charge under all conditions.

- Perfect for parks, parking lots, school campuses, etc.
- Advanced new LiFePO4 battery lasts at least 2000 charge cycles and will last up to three nights with one day charge (motion sensing mode)
- Compares to 250W HID
- Easily programmable via remote control (available for purchase)
- Pre-programmed to run at 80% output for 2 hours, then switch to reduced power when no motion is detected. It returns to 80% output with motion
- Built-in motion sensor, photo control & status indicator
- Exceptional cold weather performance due to low temperature battery chemistry
- For line drawings and mounting see pg. 3

**FITS ON A  
2-3/8" TENON**

**FLEXCOLOR**  
SWITCH BETWEEN 3 CCTs



BATTERY CHARGE TIME

BATTERY CHARGE TEMP

BATTERY LIFE

REPLACEABLE BATTERY

TYPE III OPTICS

OPERATING TEMP

100,000hrs RATED LIFE

PART #	UPC	COMPARABLE TO	LUMENS	CCT	DIMENSIONS*	WEIGHT	EPA
SL-SAL-60L-FC-T3-BK-G3	197810015000	250W HID	6000	FLEXCOLOR 3000K/4000K/5000K	36" X 26" X 32"	45 LBS.	4.5

OPERATING MODES  TIMER  MOTION SENSING

\*DIMENSIONS ARE BASED ON MOST POPULAR CONFIGURATION

**Light Efficient Design**

847.380.3540 • led-llc.com • sales@led-llc.com

LIGHT ENGINE	
LED	192 LED. 3030 HIGH EFFICACY
MAX. POWER	30W
EFFICACY	160+ LUMENS PER WATT
CRI	70+
MAX. LUMENS	6,000 LUMENS
CCT	3000K, 4000K, 5000K SELECTABLE
CONTROLLER	MPPT CHARGE CONTROLLER
OPTICS OPTIONS	TYPE 2, TYPE 3, TYPE 4, TYPE 5
SHEILD OPTIONS	BACK LIGHT SHIELD, FULL CUTOFF SHIELD

BATTERY	
TYPE	LIFEPO4
CHARGING TEMP	-4° TO 140°F
DISCHARGING TEMP	-40° TO 140°F
REPLACEABLE	YES
CHARGE CYCLES	2000+
CHARGE VOLTAGE	14.6V
AMPERE-HOURS	23.5
WATT HOURS	300
WEIGHT	5.8LBS
BMS SYSTEM	ONBOARD FULL PROTECTION

SOLAR PANEL	
TYPE	MONOCRYSTALLINE
WATTS	55W PER PANEL
VOLTAGE	12V
ADJUSTABLE	ANGLE AND ROTATION ARE FULLY ADJUSTABLE
CHARGE TIME	6 HOURS
DIMENSIONS	26.2" X 19.2" X 1.7"
WEIGHT	28.0 LB (INCLUDING BATTERY)
INGRESS PROTECTION	IP65

AREA LIGHT ASSEMBLY	
DESCRIPTION	30W / 6000 LUMEN AREA LIGHT
EPA	4.5
WEIGHT	45 LB

SOLAR AREA LIGHT ACCESSORIES

PART #	UPC	DESCRIPTION
SL-AL1-SHIELD-1	197810025320	BACK LIGHT SHIELD
SL-AL1-SHIELD-2	197810025337	FULL CUTOFF SHIELD
SL-AL1-LENS-T2	197810025344	LENS SET TYPE 2 OPTICS
SL-AL1-LENS-T3 *	197810025351	LENS SET TYPE 3 OPTICS
SL-AL1-LENS-T4	197810025368	LENS SET TYPE 4 OPTICS
SL-AL1-LENS-T5	197810025375	LENS SET TYPE 5 OPTICS

\* AREA LIGHT IS SHIPPED WITH TYPE 3 LENSES INSTALLED

REMOTE CONTROL

PART #	UPC	DESCRIPTION
SL-SAL-REMOTE-60L-G3-D	197810029144	REMOTE CONTROL FOR SL-SAL-60L-G3 DEFAULT PROGRAM: 2 HOURS AT 80% CONSTANT FOLLOWED BY SENSOR MODE 80% HIGH / 20% IDLE *

\* FOR CUSTOM PROGRAMMING, PLEASE SEND A REQUEST TO TECH SUPPORT (SOLERA-TS@LED-LLC.COM)

Light Efficient Design

847.380.3540 • led-llc.com • sales@led-llc.com

DIMENSIONS

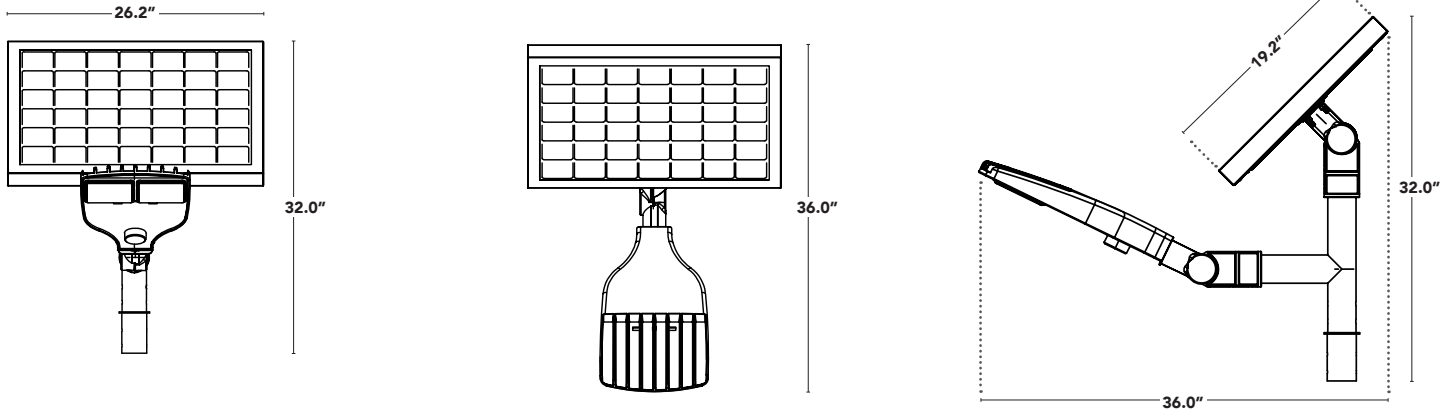

MOUNTING

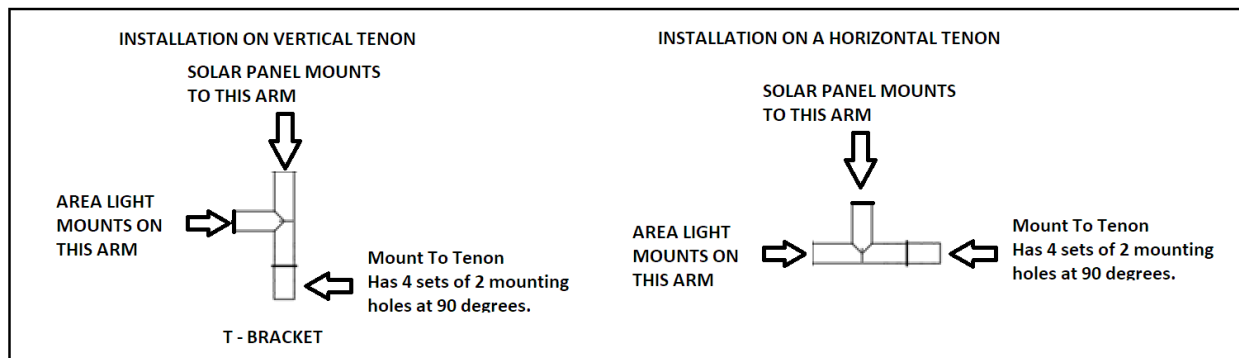

BRACKETS

PART #	DESCRIPTION
SL-SAL-BKT-RP-BK-G1	ROUND POLE BRACKET
SL-SAL-BKT-SP-BK-G1	SQUARE POLE BRACKET
SL-SAL-BKT-WM-BK-G1	WALL MOUNT BRACKET

STANDARD SLIP FITTER MOUNTING BACKET INCLUDED  
CONTACT US ADDITIONAL BRACKET OPTIONS

FOR USE W/ SL-SAL OFF-GRID



ROUND POLE



SQ POLE





WALL MOUNT

Light Efficient Design

847.380.3540 • led-llc.com • sales@led-llc.com

PHOTOMETRICS - DEFAULT CONFIGURATION\*

FOOT CANDLES	ISO-LINE COLOR
1 FC	BLACK 
0.5 FC	MAGENTA 
0.1 FC	BLUE 

\* T3 IS DEFAULT LENS W/ LIGHT OUTPUT SET TO 80%

ILLUMINANCE (FC)

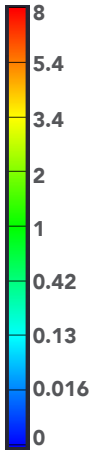

MOUNTING HEIGHT : 15 FT

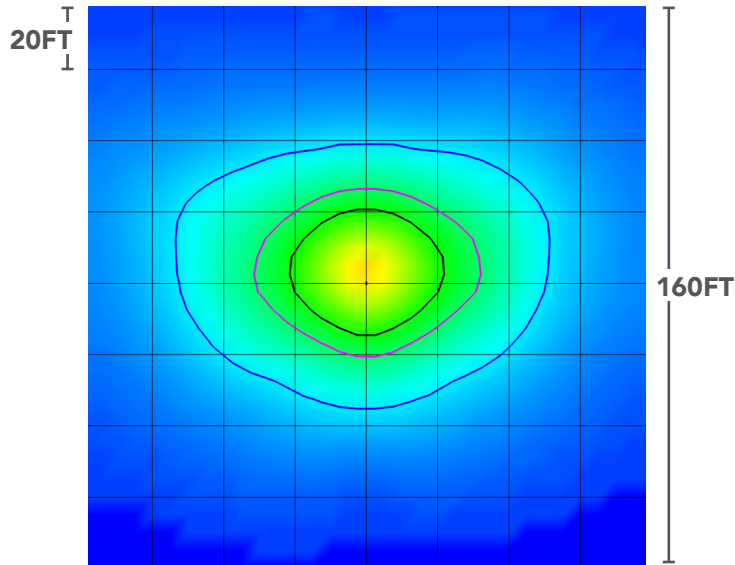

MOUNTING HEIGHT : 20 FT

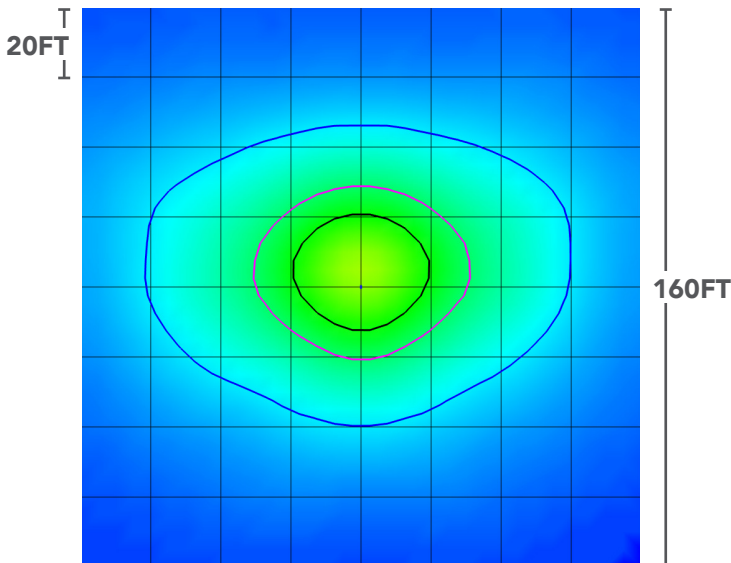

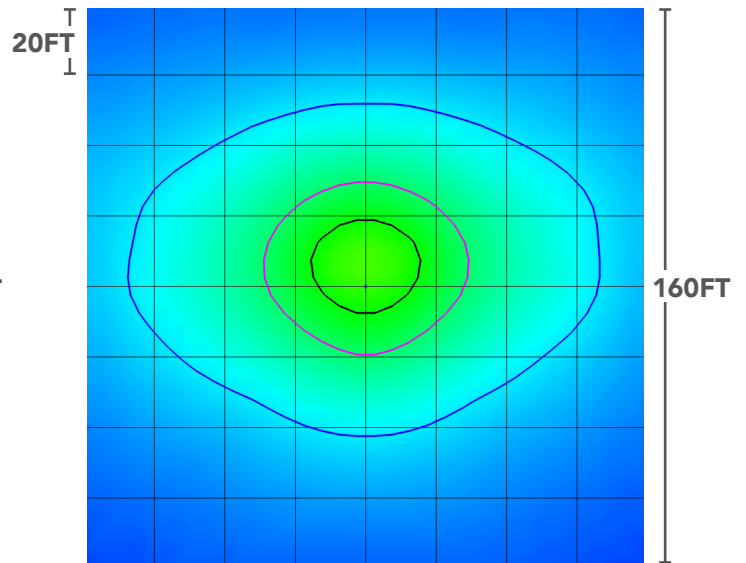

MOUNTING HEIGHT : 25 FT



Light Efficient Design

847.380.3540 • led-llc.com • sales@led-llc.com

PHOTOMETRICS - OPTIONAL LENSES AND SHIELDS

FOOT CANDLES	ISO-LINE COLOR	
1 FC	BLACK	
0.5 FC	MAGENTA	
0.1 FC	BLUE	

\* T3 IS DEFAULT LENS W/ LIGHT OUTPUT SET TO 80%

ILLUMINANCE (FC)

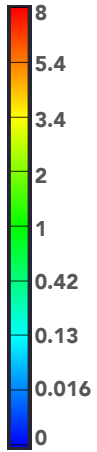

MOUNTING HEIGHT : 20 FT

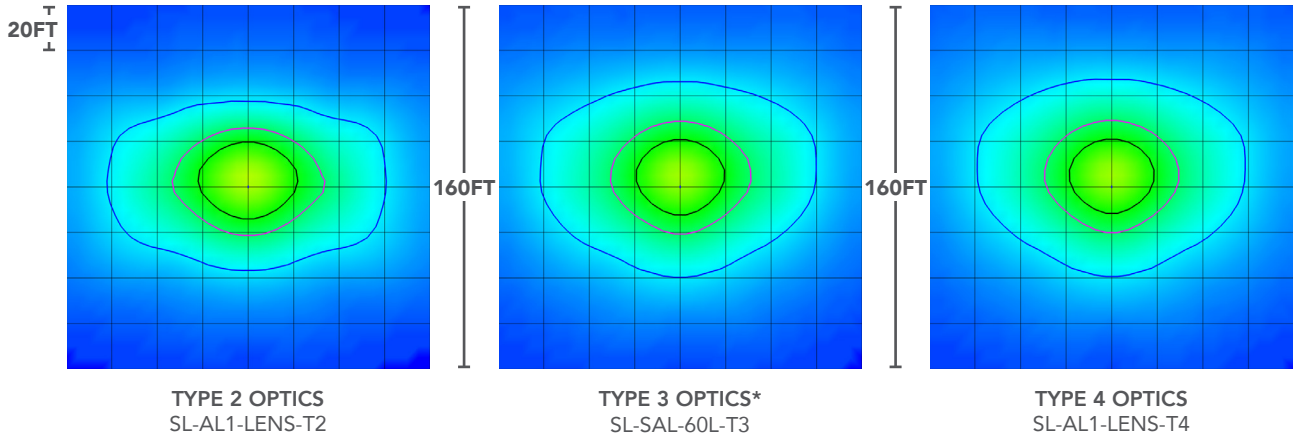

MOUNTING HEIGHT : 20 FT

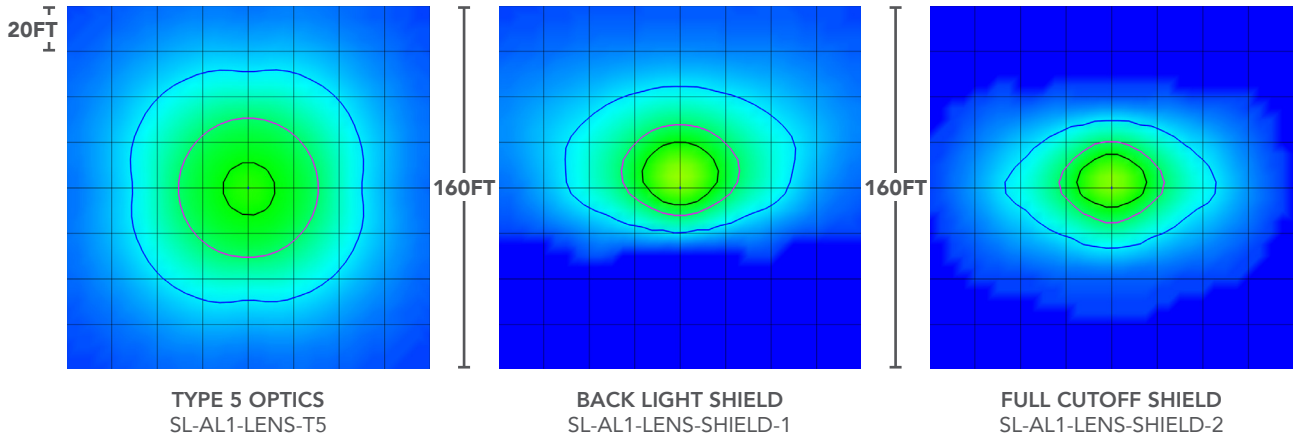

Light Efficient Design

847.380.3540 • led-llc.com • sales@led-llc.com