

EASY TO
INSTALL

FOR POLE MOUNTING 4 U-BOLTS ARE
REQUIRED SEE PG.2 FOR MORE DETAILS.
(U-BOLTS NOT INCLUDED)

Solera Solar Lighting 50W Off-Grid area light can be use completely off-grid. High Performance solar controller maximizes solar charge under all conditions.

- Off-Grid – completely free to operate, plus no trenching or wiring required.
- All-in-one design.
- Exclusive long-lasting battery withstands extreme temperatures.
- Easy to install and operate.
- Adjustable solar panel — can be mounted up to 16 ft away from light engine.
- Custom optics and color temperatures available.
- Advanced battery lasts at least 2,000 charge cycles.
- See pg. 2 for product dimensions & accessories.
- See pg. 3 for photometrics.



CERTIFIED BATTERY



BATTERY
CHARGE TIME



BATTERY
CHARGE TEMP



BATTERY LIFE



REPLACEABLE
BATTERY



MOTION
SENSING



OPERATING TEMP



100,000hrs
RATED LIFE

PART #	UPC	COMPARES TO	LUMENS	COLOR	EPA	LISTINGS
SL-SAL-OG-50W-50K-SF-BK-G2	844006081423	400W	9800	5000K	6.1	

OPERATING MODES |  TIMER |  MOTION SENSING

BRACKET & ADDITIONAL SOLAR PANEL - MUST ORDER SL-SAL-50W-2PANELKIT SEPARATELY (SHIPPED IN A SEPARATE BOX)

PART #	DESCRIPTION
SL-SAL-50W-2PANELKIT	2X 50W SOLAR PANELS, 10 FOOT EXTENSION CABLE, 6 FOOT Y-CABLE, ADJUSTABLE BRACKET

 FOR LISTING STATUS GO TO LED-LLC.COM

Light Efficient Design

847.380.3540 • led-llc.com • sales@led-llc.com

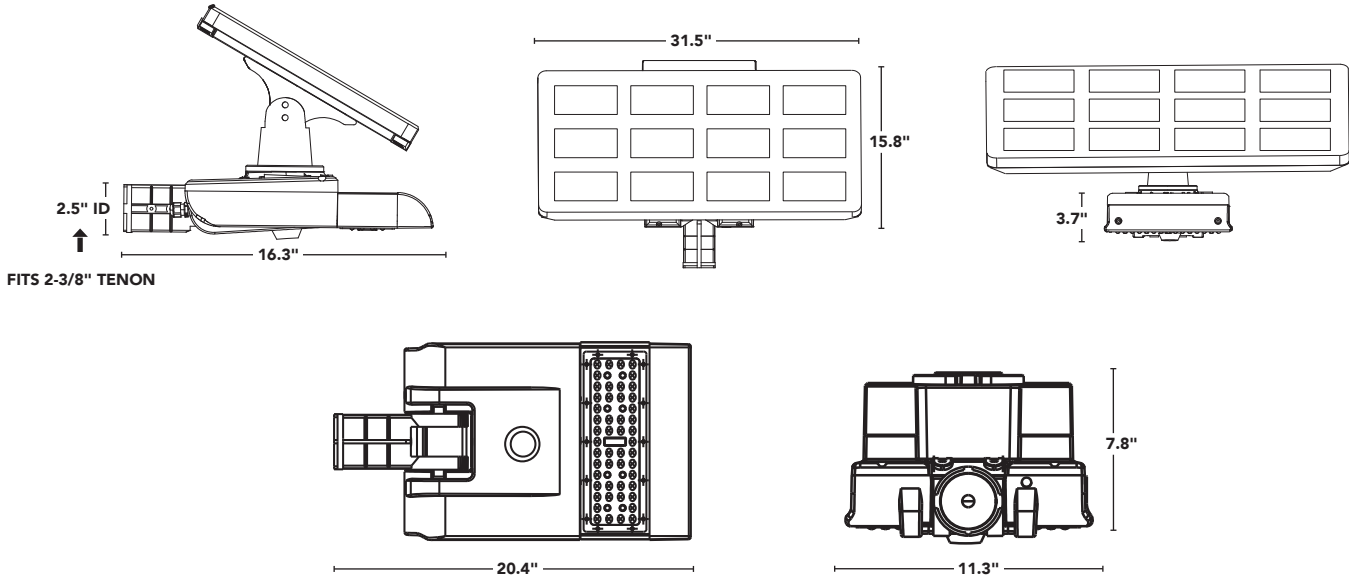

ACCESSORIES

BRACKETS

PART #	DESCRIPTION
SL-SAL-BKT-RP-BK-G1	ROUND POLE BRACKET
SL-SAL-BKT-SP-BK-G1	SQUARE POLE BRACKET
SL-SAL-BKT-ST-3-BK-G1	TENON ADAPTER FOR 3" SQUARE POLE
SL-SAL-BKT-RT-3-BK-G1	TENON ADAPTER FOR 3" ROUND POLE
SL-SAL-BKT-WM-BK-G1	WALL MOUNT BRACKET
SL-BKT-KIT-099	TENON MOUNTING KIT FOR SOLAR PANELS

STANDARD SLIP FITTER MOUNTING BRACKET INCLUDED.

CONTACT US FOR ADDITIONAL BRACKET OPTIONS.

OPTIONAL MOUNTING HARDWARE (NOT INCLUDED)

PART #	DESCRIPTION	QTY REQ.
SL-UBOLT-4IN-ROUND	FITS 4" ROUND POLE	4 U-BOLTS
SL-UBOLT-4IN-SQUARE	FITS 4" SQUARE POLE	
SL-UBOLT-5IN-ROUND	FITS 5" ROUND POLE	
SL-UBOLT-5IN-SQUARE	FITS 5" SQUARE POLE	



FOR USE W/ SL-SAL OFF-GRID + HYBRID MODELS



Light Efficient Design

847.380.3540 • led-llc.com • sales@led-llc.com

PHOTOMETRICS

FOOT CANDLES	ISO-LINE COLOR
1 FC	BLACK 
0.5 FC	MAGENTA 
0.1 FC	BLUE 

ILLUMINANCE (FC)

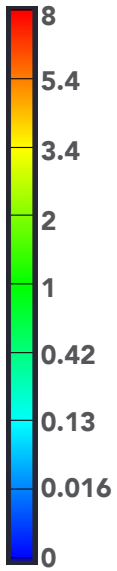

MOUNTING HEIGHT : 20FT

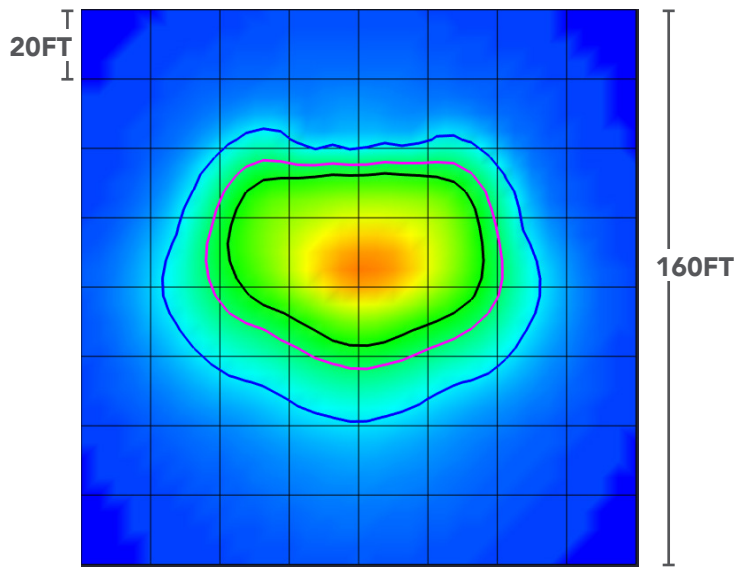

MOUNTING HEIGHT : 25FT

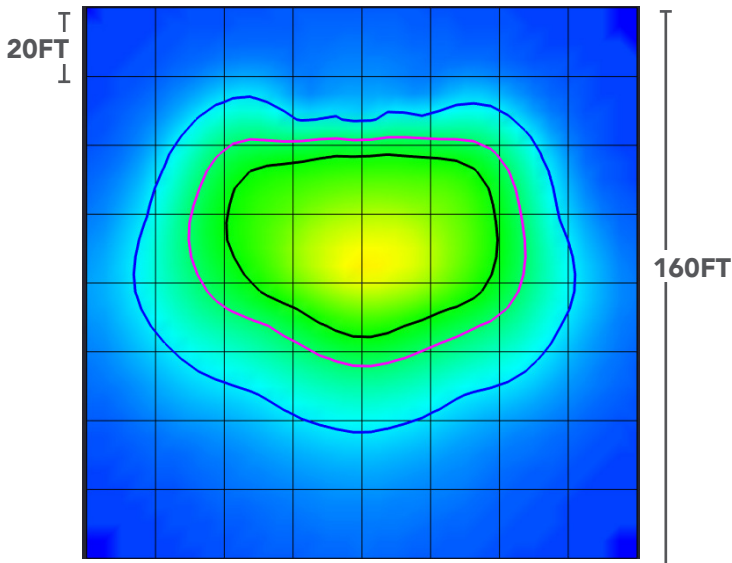

MOUNTING HEIGHT : 30FT

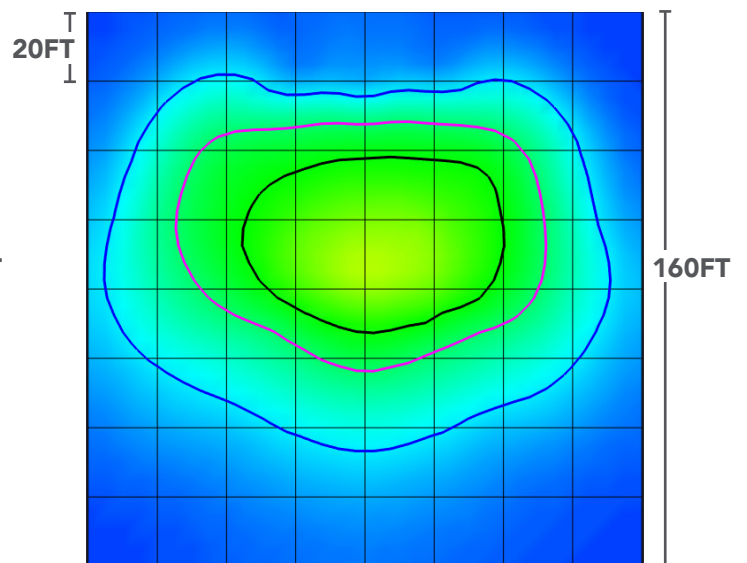

Light Efficient Design

847.380.3540 • led-llc.com • sales@led-llc.com