



all-in-one  
Design ↓



All-in-one design with solar panel, light engine and battery built into the fixture. Completely off-grid, no need for wiring or trenching. Easy to install on a standard 3 inch pole w/ supplied screws.

- Comparable to 150W HID.
- Perfect for parks, city streets, school campuses and any pedestrian walkway.
- Automatically turns on at night and can be set to different operating modes including constant output and bi-level dimming with motion sensing.
- Constructed of stong & lightweight aluminum alloy.
- 3.2V/50AH LiFePO4 battery.
- 165 lumens per watt.
- See pg. 2 for dimensions.
- See pg. 3 for photometrics.

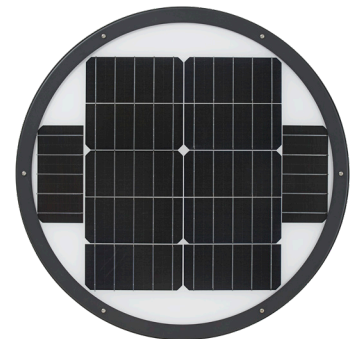

BATTERY CHARGE TIME

BATTERY CHARGE TEMP

BATTERY LIFE\*

REPLACEABLE BATTERY

BEAM ANGLE

OPERATING TEMP

50,000hrs RATED LIFE

PART #	UPC	COMPARES TO	LUMENS	COLOR	LISTINGS
SL-CPT-25L-30K-BK-G1	844006088385	150W	2500	3000K	CE FC
SL-CPT-25L-40K-BK-G1	844006088392			4000K	

#### ACCESSORIES

PART #	DESCRIPTION	OPERATING MODES
SL-CPT-BATTERY	REPLACEMENT BATTERY	☀️ CONSTANT BRIGHTNESS ⌚ TIMER 🚶 MOTION SENSING

\* ON 2HR + SENSOR MODE.

## Light Efficient Design

847.380.3540 • led-llc.com • sales@led-llc.com



**PART NUMBER BUILDER**

MFR	PRODUCT	LUMENS	COLOR TEMP	FIXTURE COLOR	GENERATION
SL	CPT	25L		BK	G1
(SOLERA)	(CIRCULAR POST TOP)	(2500 LUMENS)	30K (3000K) 40K (4000K)	(BLACK)	(GENERATION 1)

**EXAMPLE PART NUMBER** SL-CPT-25L-30K-BK-G1

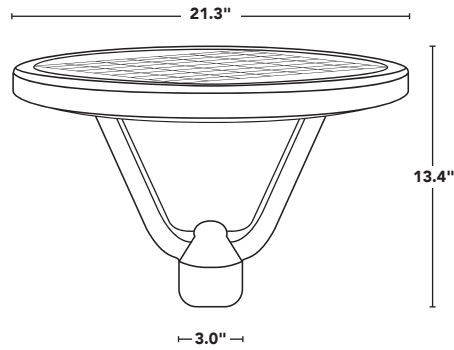

**DIMENSIONS**



**Light Efficient Design**

847.380.3540 • led-llc.com • sales@led-llc.com

PHOTOMETRICS

FOOT CANDLES	ISO-LINE COLOR
1 FC	BLACK 
0.5 FC	MAGENTA 
0.1 FC	BLUE 

ILLUMINANCE (FC)

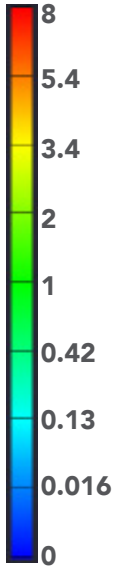

MOUNTING HEIGHT : 8FT

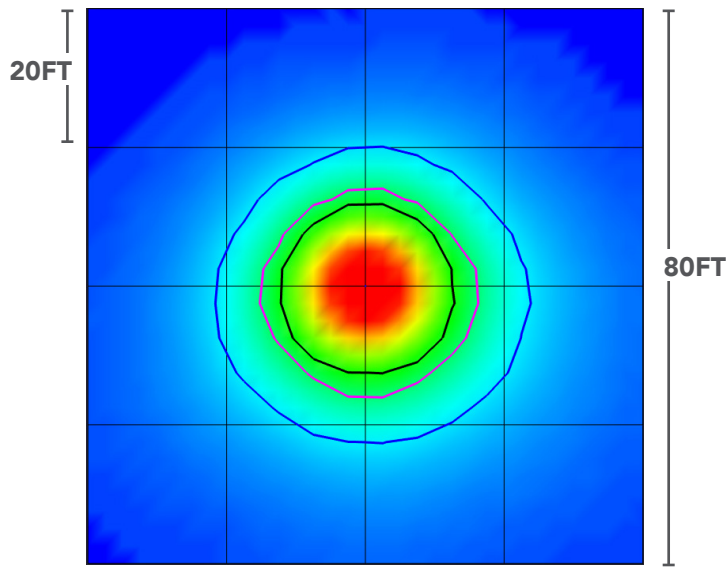

MOUNTING HEIGHT : 12FT

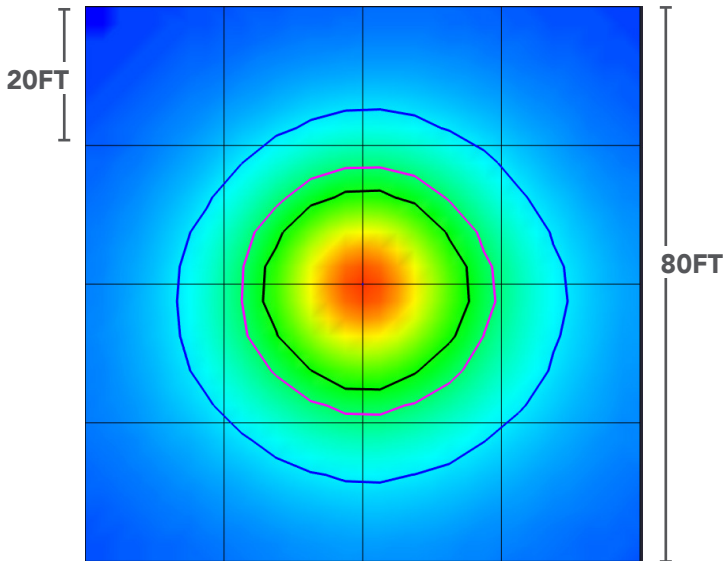

MOUNTING HEIGHT : 15FT

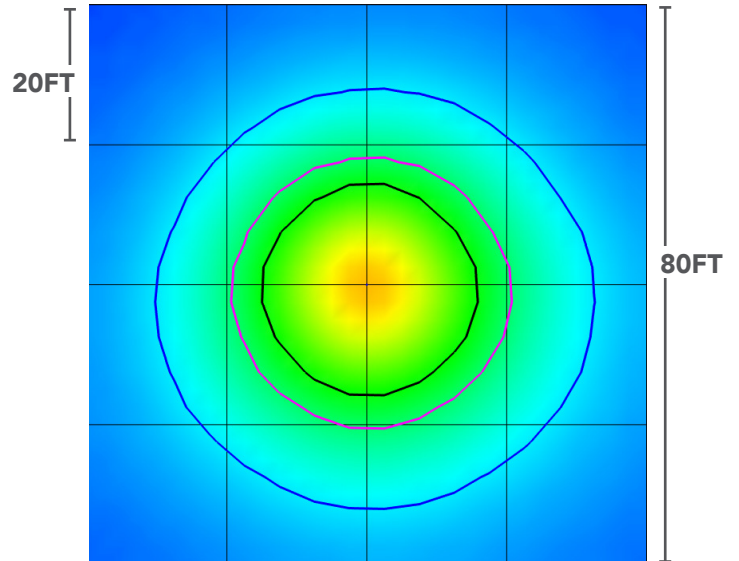

Light Efficient Design

847.380.3540 • led-llc.com • sales@led-llc.com